

DRZWI UCHYLNE

Instrukcja montażu

(Dla modelu ONP2-90/100)

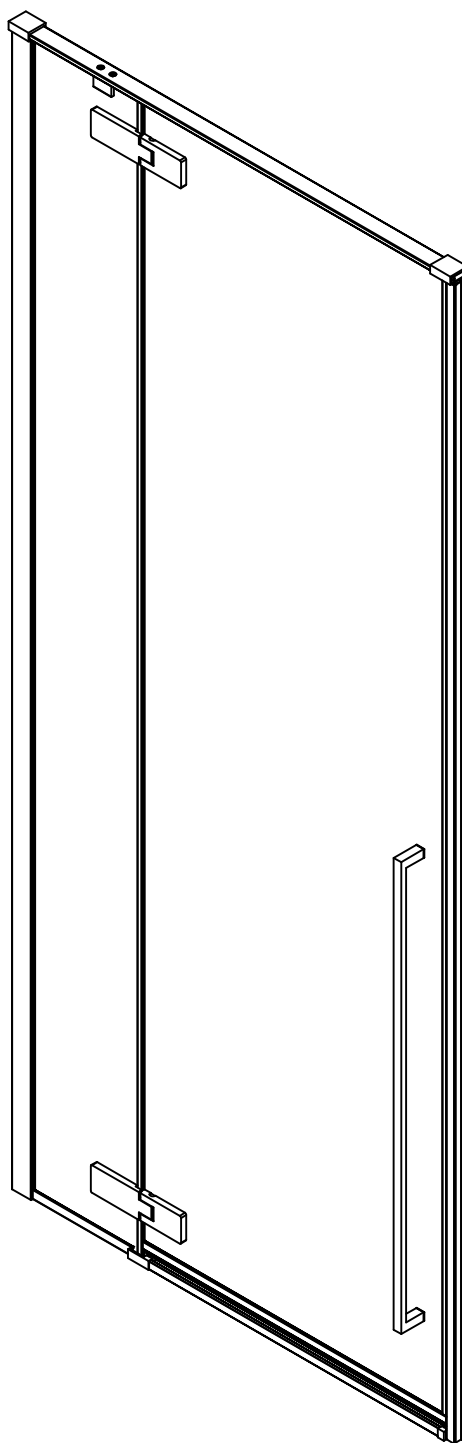

■ INFORMACJE OGÓLNE:

Prosimy sprawdzić produkt niezwłocznie po otrzymaniu czy nie nosi żadnych uszkodzeń transportowych, czy ilość części jest kompletna i czy produkt nie posiada żadnych wad produkcyjnych. Reklamacje w późniejszym terminie mogą nie zostać uznane.

Należy szczególnie chronić krawędzie szyby przed uderzeniem o twardą powierzchnię.

■ MONTAŻ:

Prosimy uważnie przeczytać instrukcję przed rozpoczęciem instalacji.

Ściana kabiny posiada 20mm zakres regulacji, który pozwala dopasowaćabinę do pionu ściany.

Szczególną ostrożność należy zachować podczas wiercenia otworów w ścianach, należy uważać na ukryte rury i przewody elektryczne.

Przed montażem kabiny zainstaluj brodzik zgodnie z instrukcją producenta, zwracając uwagę na wypoziomowanie brodzika we wszystkich kierunkach.

Szczeliny między kabiną a brodzikiem i ścianami należy dokładnie wypełnić silikonem.

Przy montażu bezpośrednio na płytkach, wykonaj spadek płytek podłogowych minimum 2,5% w stanowisku prysznicowym. Spadek powinien zaczynać się od osi elementów dolnych poziomych kabiny tj. szyby, progu itp. Granica spadku powinna odwzorować kształt kabiny. Zaleca się wykonanie 2mm uskoku płytek na granicy kabiny.

wymiary kabiny z uwzględnieniem osi szkła są dostępne w katalogu i na stronie internetowej

UWAGA: Produkt jest ciężki i wymaga dwóch osób do montażu.

Należy usunąć folię ochronną z profili aluminiowych przed instalacją.

W przypadku wystąpienia trudności montażowych lub niejasności w instrukcji - prosimy niezwłocznie skontaktować się z Serwisem Atrium.

■ EKSPLOATACJA:

Po każdej kąpieli należy spłukać wnętrze kabiny czystą bieżącą wodą. Pozostałe na szybach resztki wody usunąć za pomoc specjalnej gumowej ściągaczki lub wytrzeć do sucha za pomoc miękkiej ściereczki. Okresowo czyścić całą kabinę przy pomocy miękkiej ściereczki (nie stosować ścierek, które zawierają w swojej strukturze elementy szorstkie i trące). Do okresowego czyszczenia stosować tylko i wyłącznie łagodne środki chemiczne przeznaczone do czyszczenia kabin prysznicowych (szyby w kabinie można czyścić środkami do mycia okien).

W celu usunięcia osadów wapiennych można stosować roztwór wody z octem.

WYMAGANE NARZĘDZIA

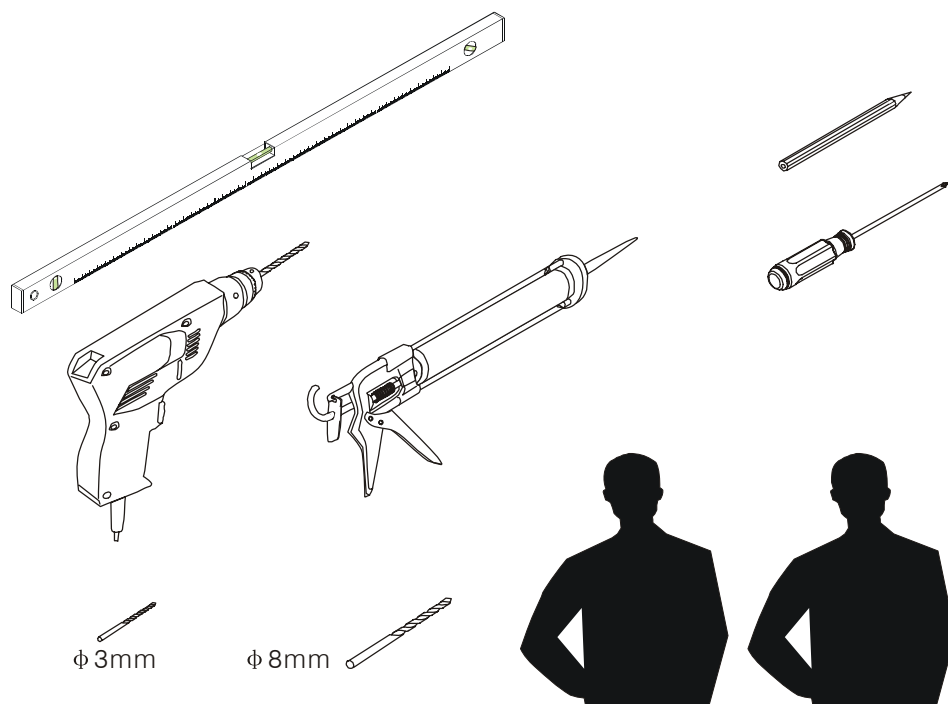

PRODUKT CIĘŻKI WYMAGA DWÓCH OSÓB DO MONTAŻU



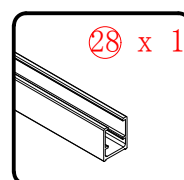
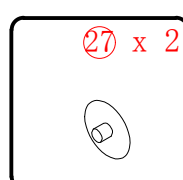
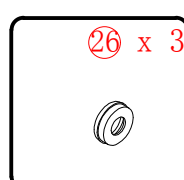
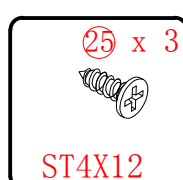
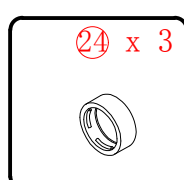
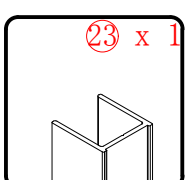
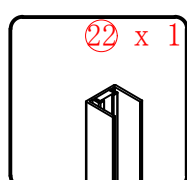
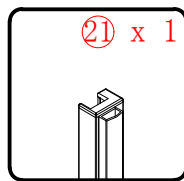
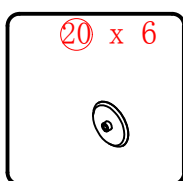
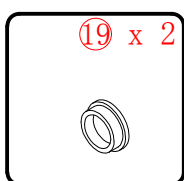
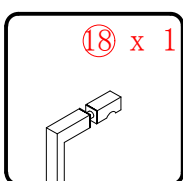
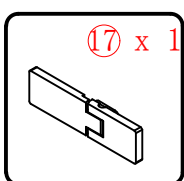
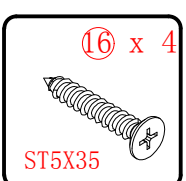
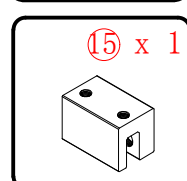
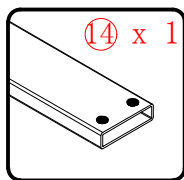
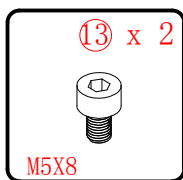
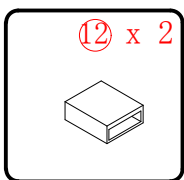
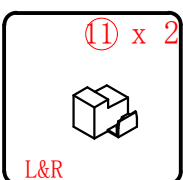
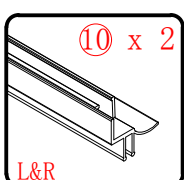
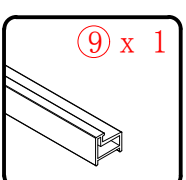
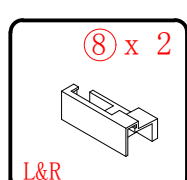
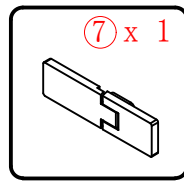
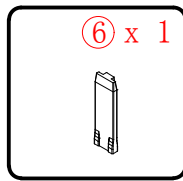
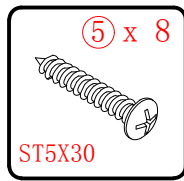
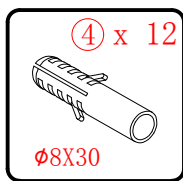
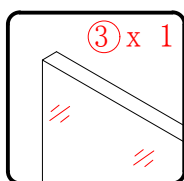
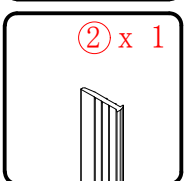
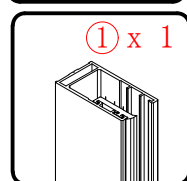
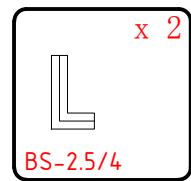
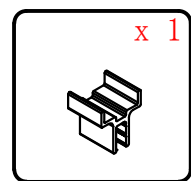
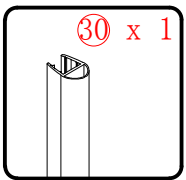
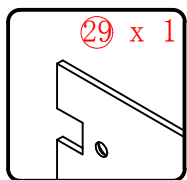
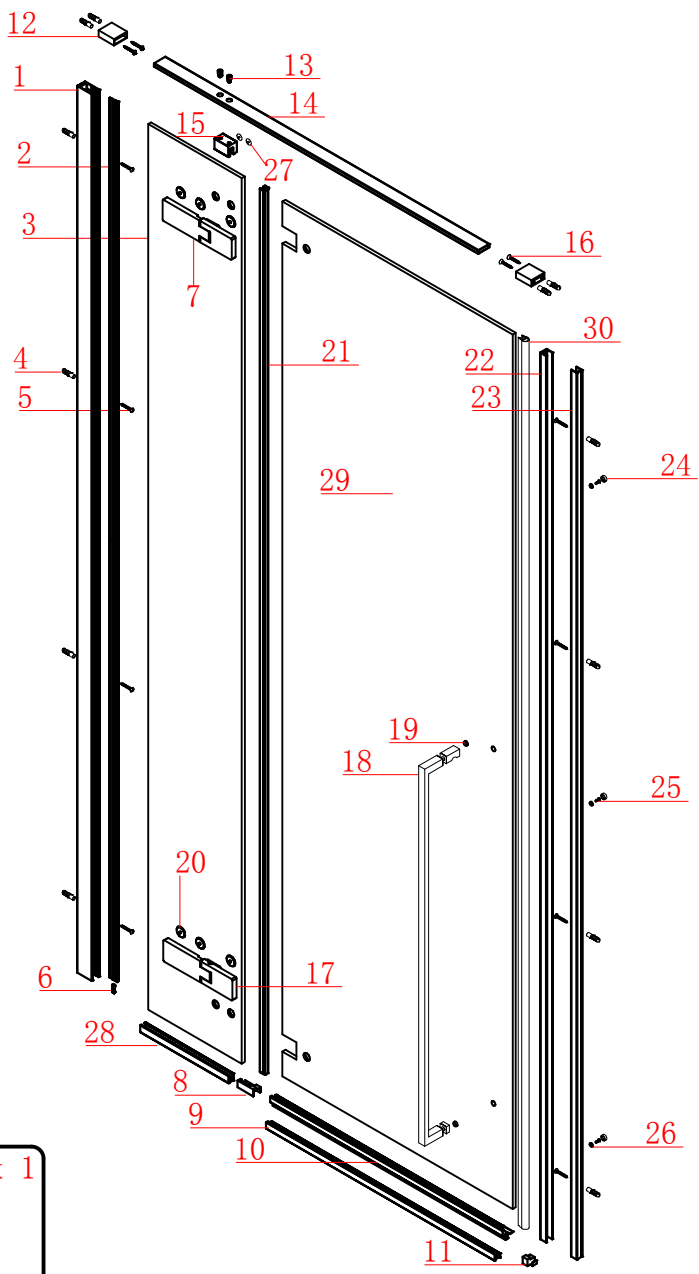

 **PRODUKT CIĘŻKI WYMAGA DWÓCH OSÓB DO MONTAŻU** 

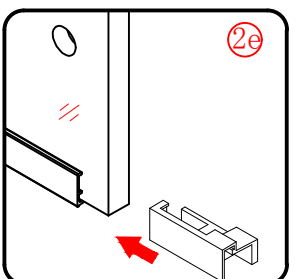
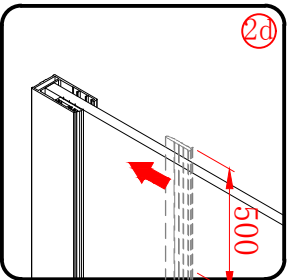
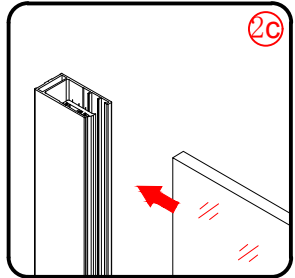
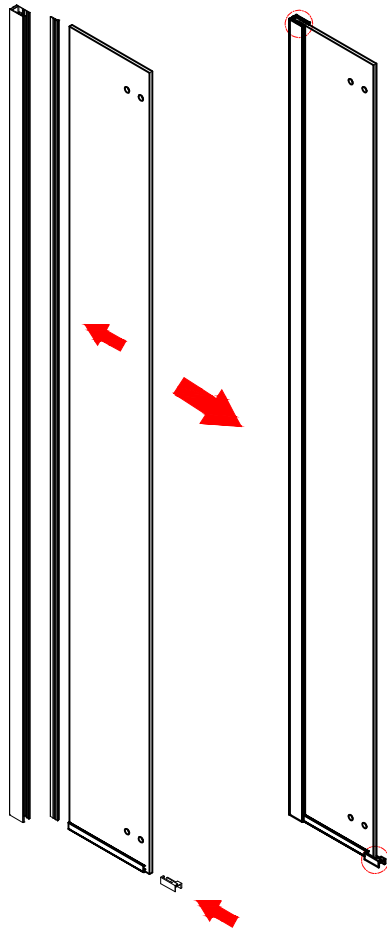
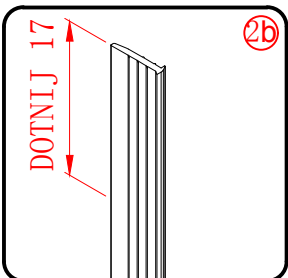
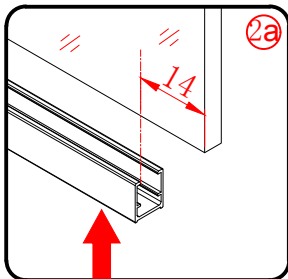
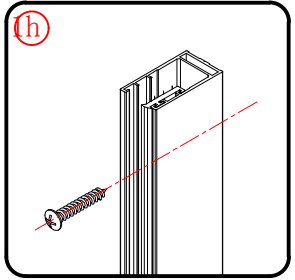
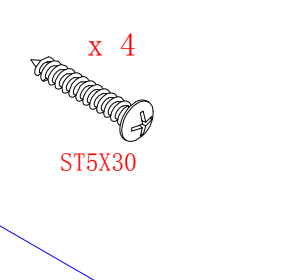
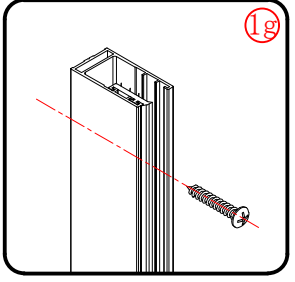
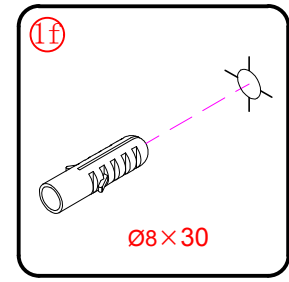
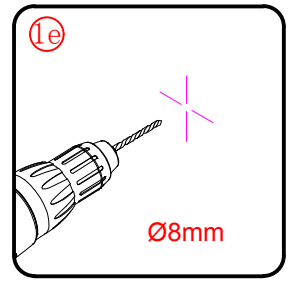
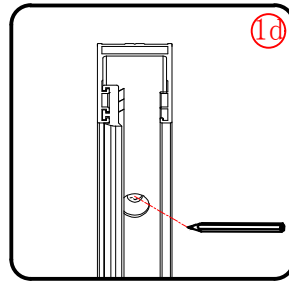
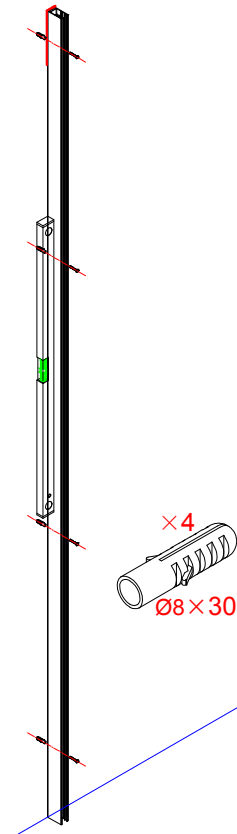
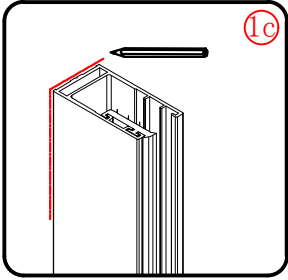
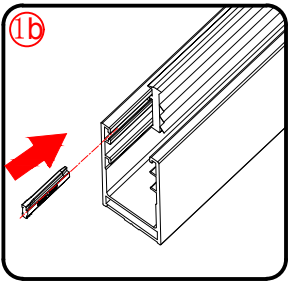
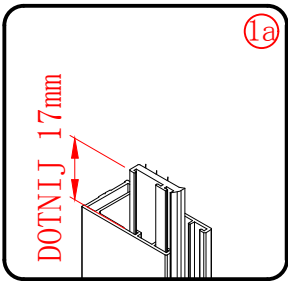

PRODUKT CIĘŻKI WYMAGA DWÓCH OSÓB DO MONTAŻU



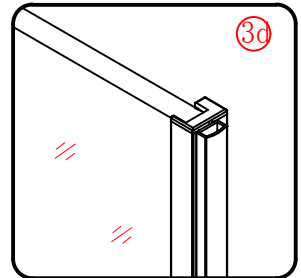
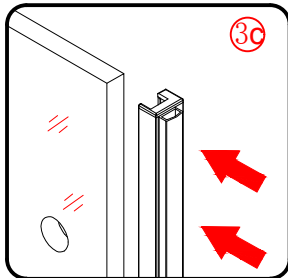
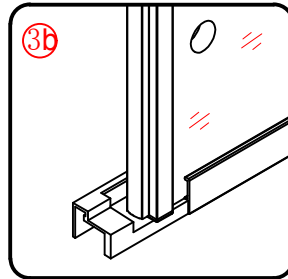
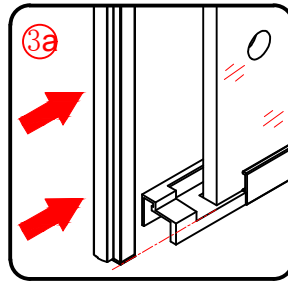
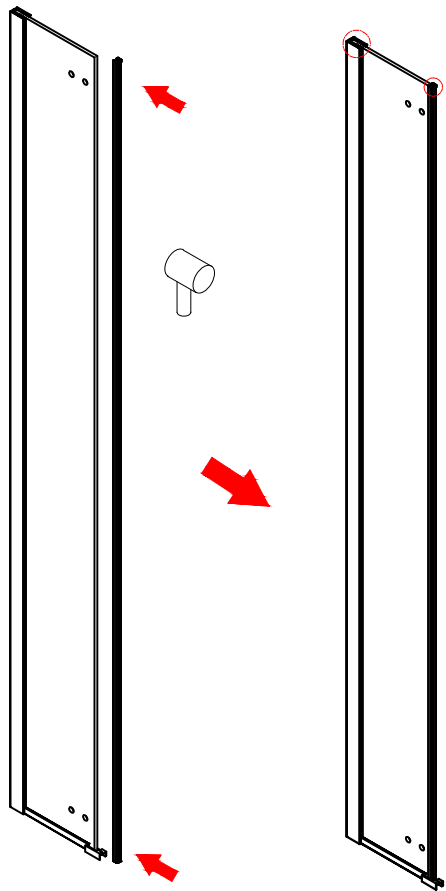

PRODUKT CIĘŻKI WYMAGA DWÓCH OSÓB DO MONTAŻU



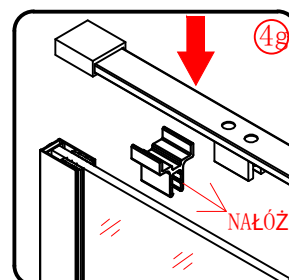
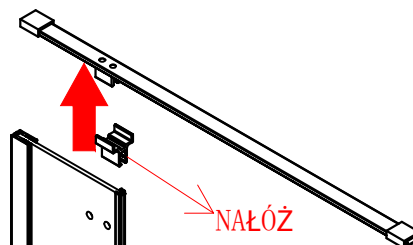
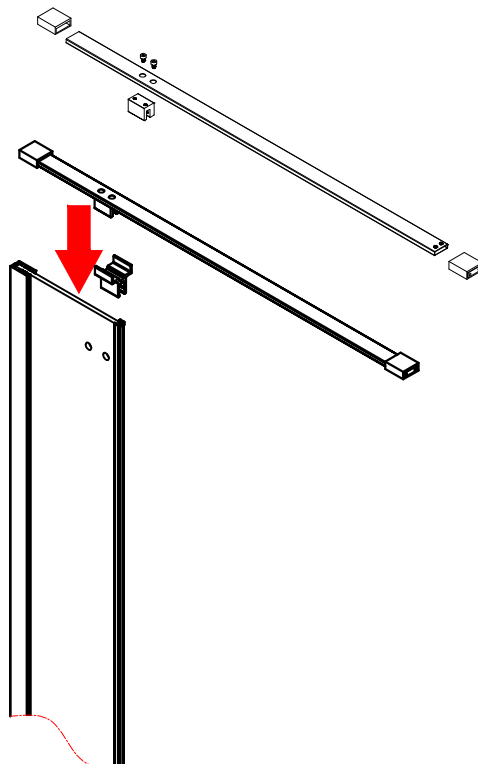
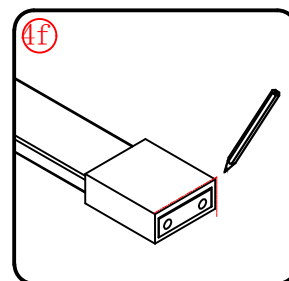
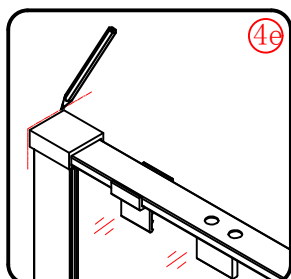
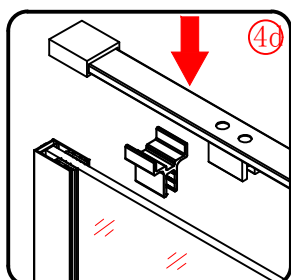
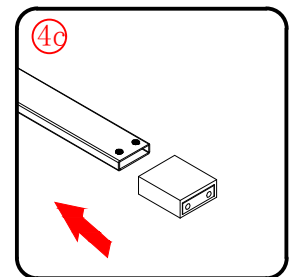
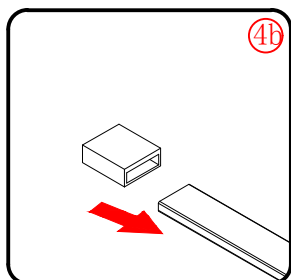
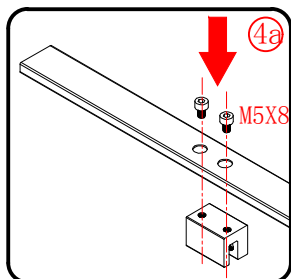

PRODUKT CIĘŻKI WYMAGA DWÓCH OSÓB DO MONTAŻU



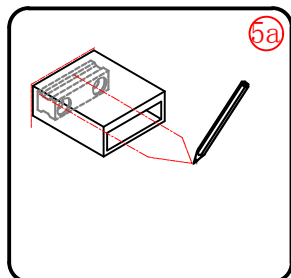

5a

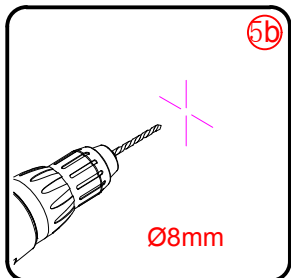

Ø8mm

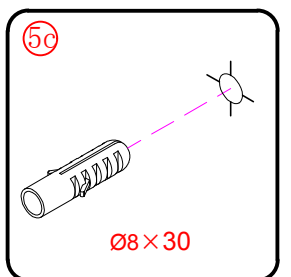

Ø8 × 30

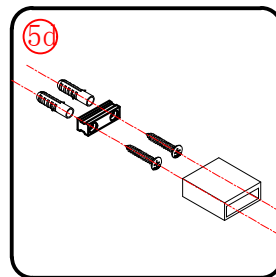
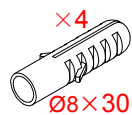

5d

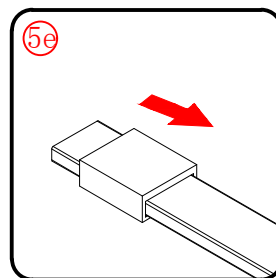

5e

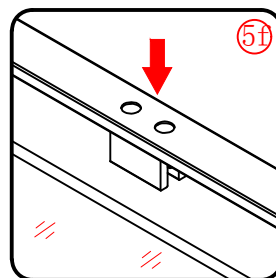

5f

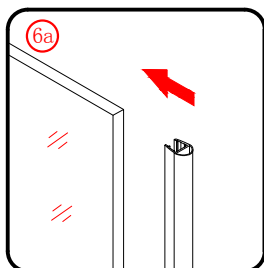
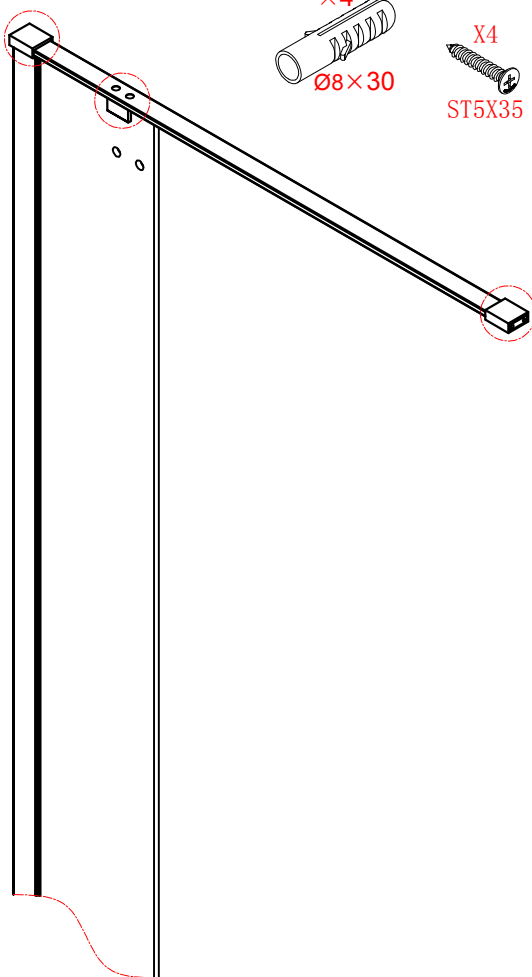

6a

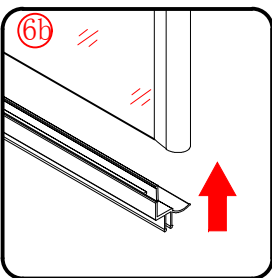

6b

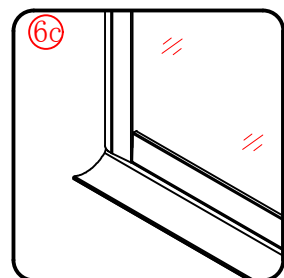

6c

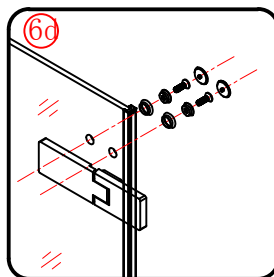

6d

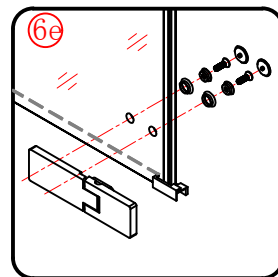

6e

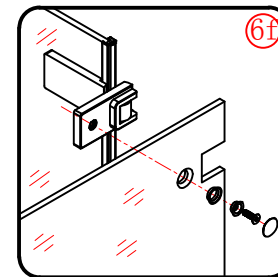

6f

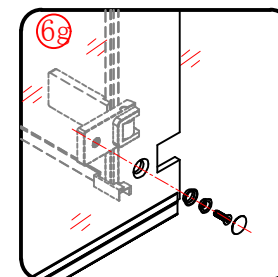

6g

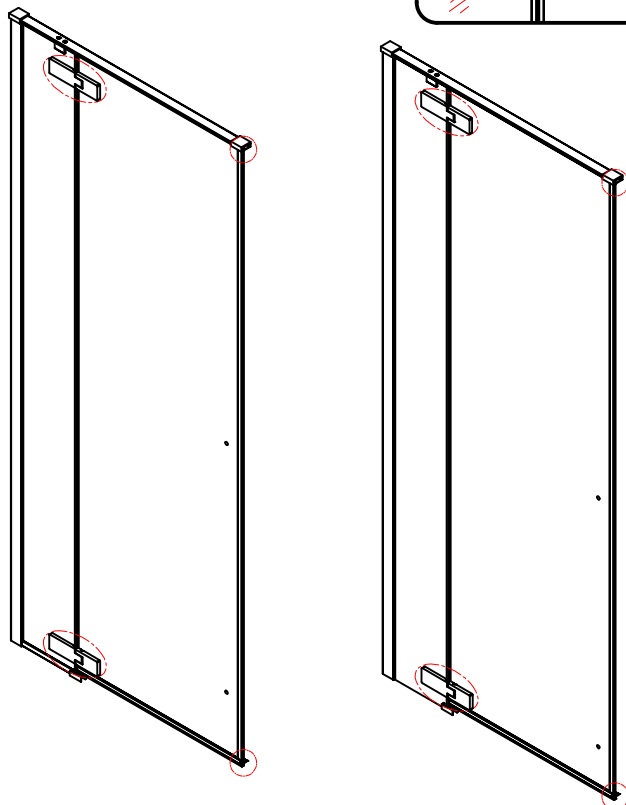

PRODUKT CIĘŻKI WYMAGA DWÓCH OSÓB DO MONTAŻU



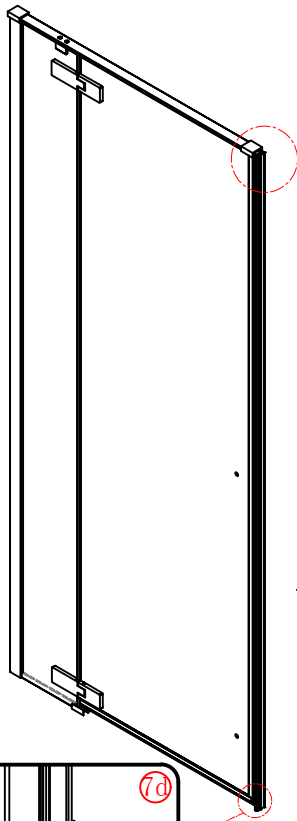
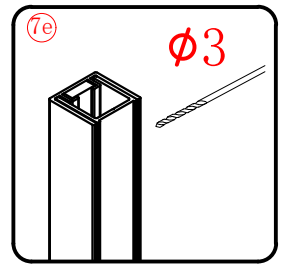
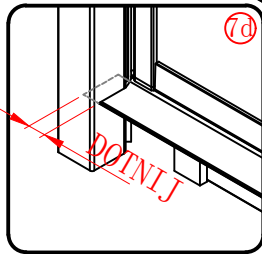
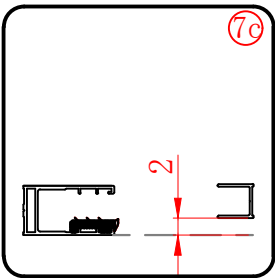
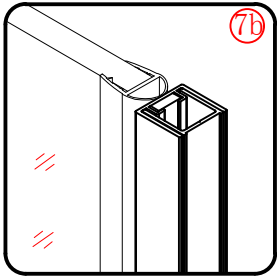
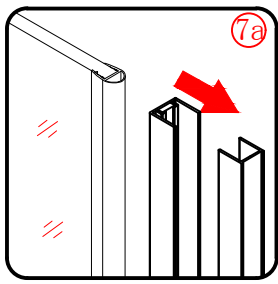

x 4
ST5X30

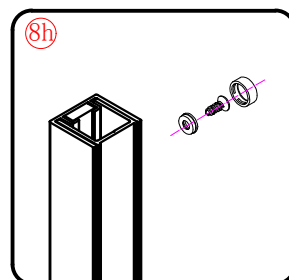
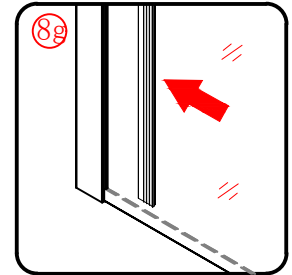
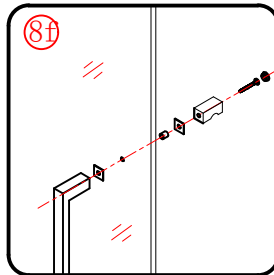
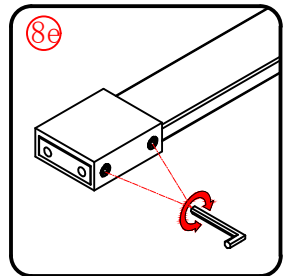
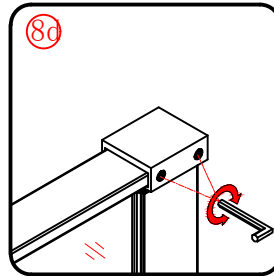
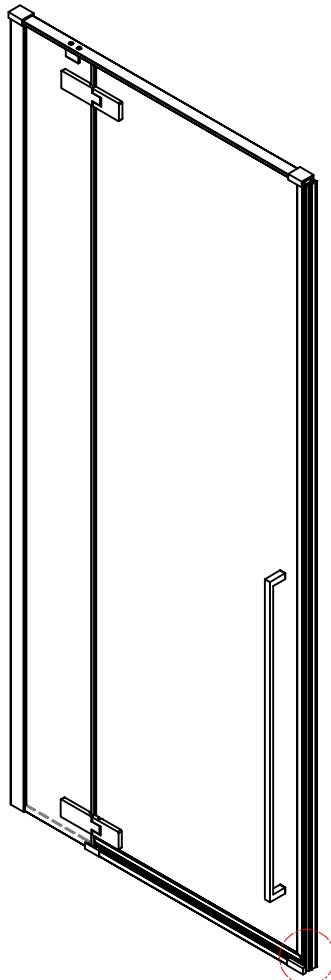
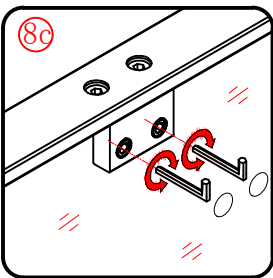
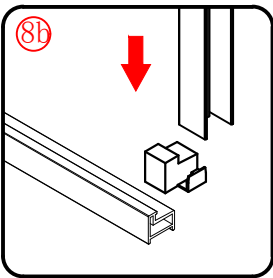
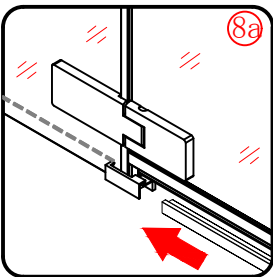

X3
ST4X12



PRODUKT CIĘŻKI WYMAGA DWÓCH OSÓB DO MONTAŻU



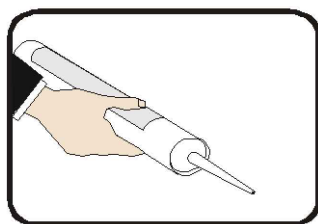
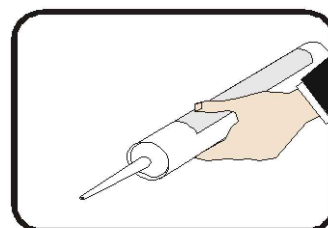
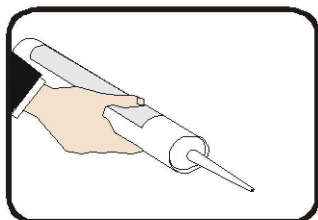
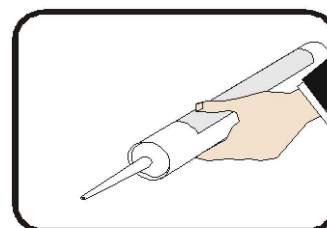
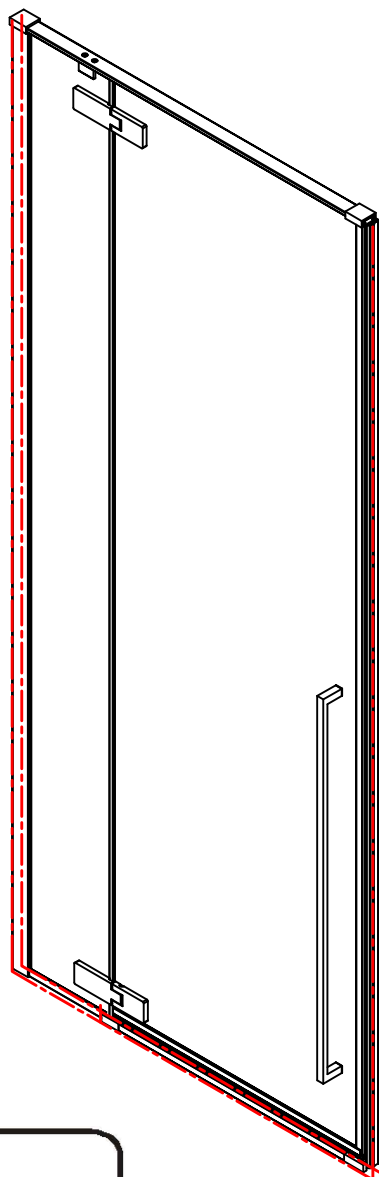
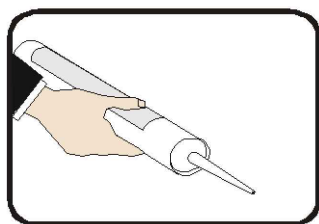
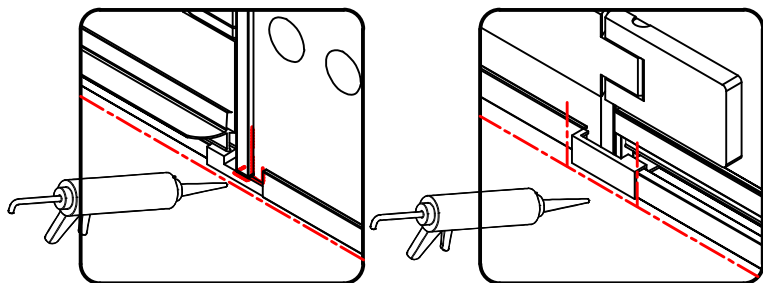

Sylikon nałoż od zewnątrz i wewnątrz kabiny



PRODUKT CIĘŻKI WYMAGA DWÓCH OSÓB DO MONTAŻU

