



SERIA-U

Drzwi skrzydłowe

INSTRUKCJA MONTAŻU

(Dla QT4)

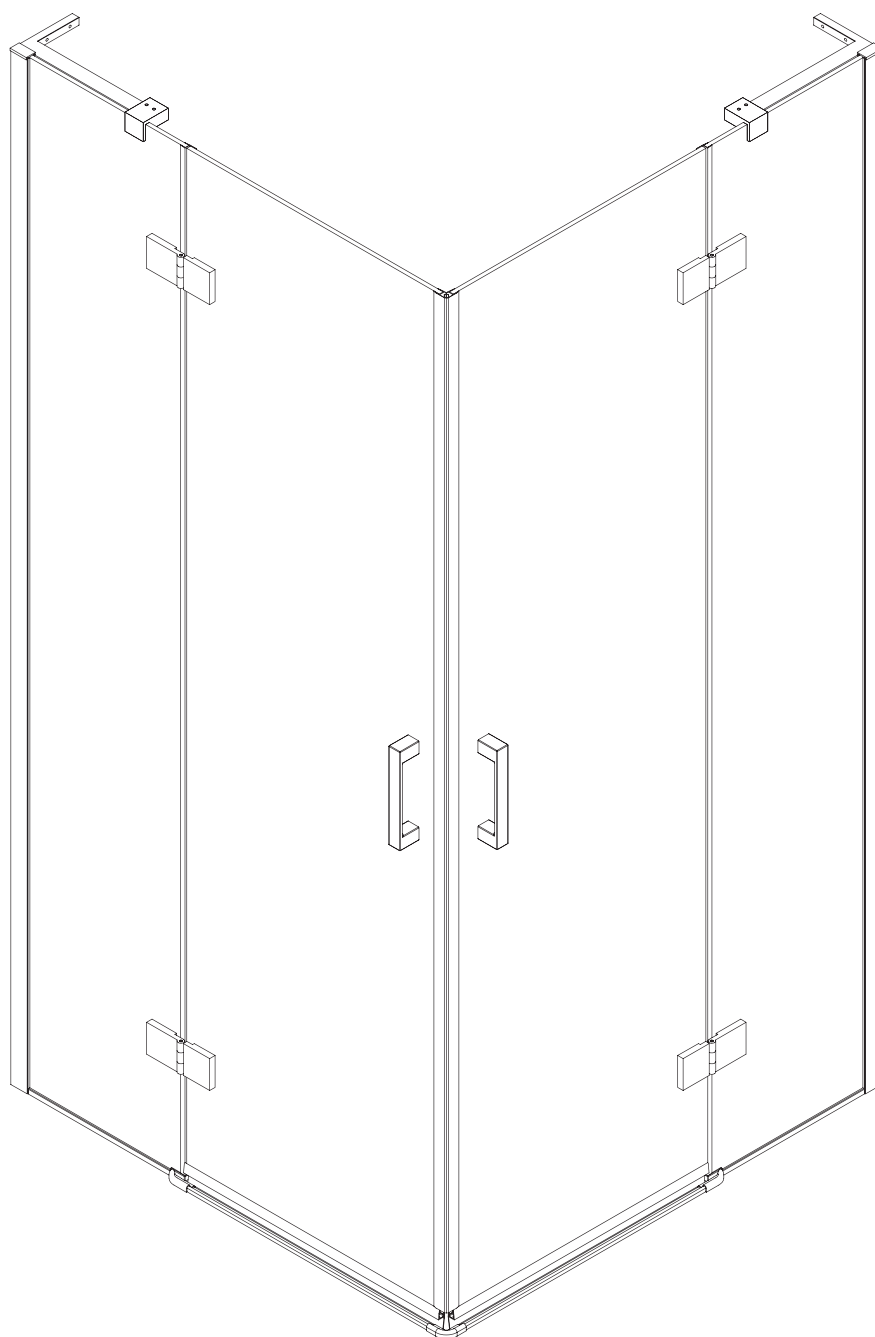

■ INFORMACJE OGÓLNE:

Prosimy sprawdzić produkt niezwłocznie po otrzymaniu czy nie nosi żadnych uszkodzeń transportowych, czy ilość części jest kompletna i czy produkt nie posiada żadnych wad produkcyjnych. Reklamacje w późniejszym terminie mogą nie zostać uznane.

Należy szczególnie chronić krawędzie szyby przed uderzeniem o twardą powierzchnię.

■ MONTAŻ:

Prosimy uważnie przeczytać instrukcję przed rozpoczęciem instalacji.

Ściana kabiny posiada 20mm zakres regulacji, który pozwala dopasować kabinę do pionu ściany.

Szczególną ostrożność należy zachować podczas wiercenia otworów w ścianach, należy uważać na ukryte rury i przewody elektryczne.

Przed montażem kabiny zainstaluj brodzik zgodnie z instrukcją producenta, zwracając uwagę na wypoziomowanie brodzika we wszystkich kierunkach.

Szczeliny między kabiną a brodzikiem i ścianami należy dokładnie wypełnić silikonem.

UWAGA: Produkt jest ciężki i wymaga dwóch osób do montażu.

Należy usunąć folię ochronną z profili aluminiowych przed instalacją.

■ EKSPLOATACJA:

Po każdej kąpielii należy spłukać wnętrze kabiny czystą bieżącą wodą. Pozostałe na szybach resztki wody usunąć za pomocą specjalnej gumowej ściągaczki lub wytrzeć do sucha za pomocą miękkiej ściereczki. Okresowo czyścić całą kabinę przy pomocy miękkiej ściereczki (nie stosować ścierek, które zawierają w swojej strukturze elementy szorstkie i trące). Do okresowego czyszczenia stosować tylko i wyłącznie łagodne środki chemiczne przeznaczone do czyszczenia kabin prysznicowych (szyby w kabinie można czyścić środkami do mycia okien).

W celu usunięcia osadów wapiennych można stosować roztwór wody z octem.

WYMAGANE NARZĘDZIA

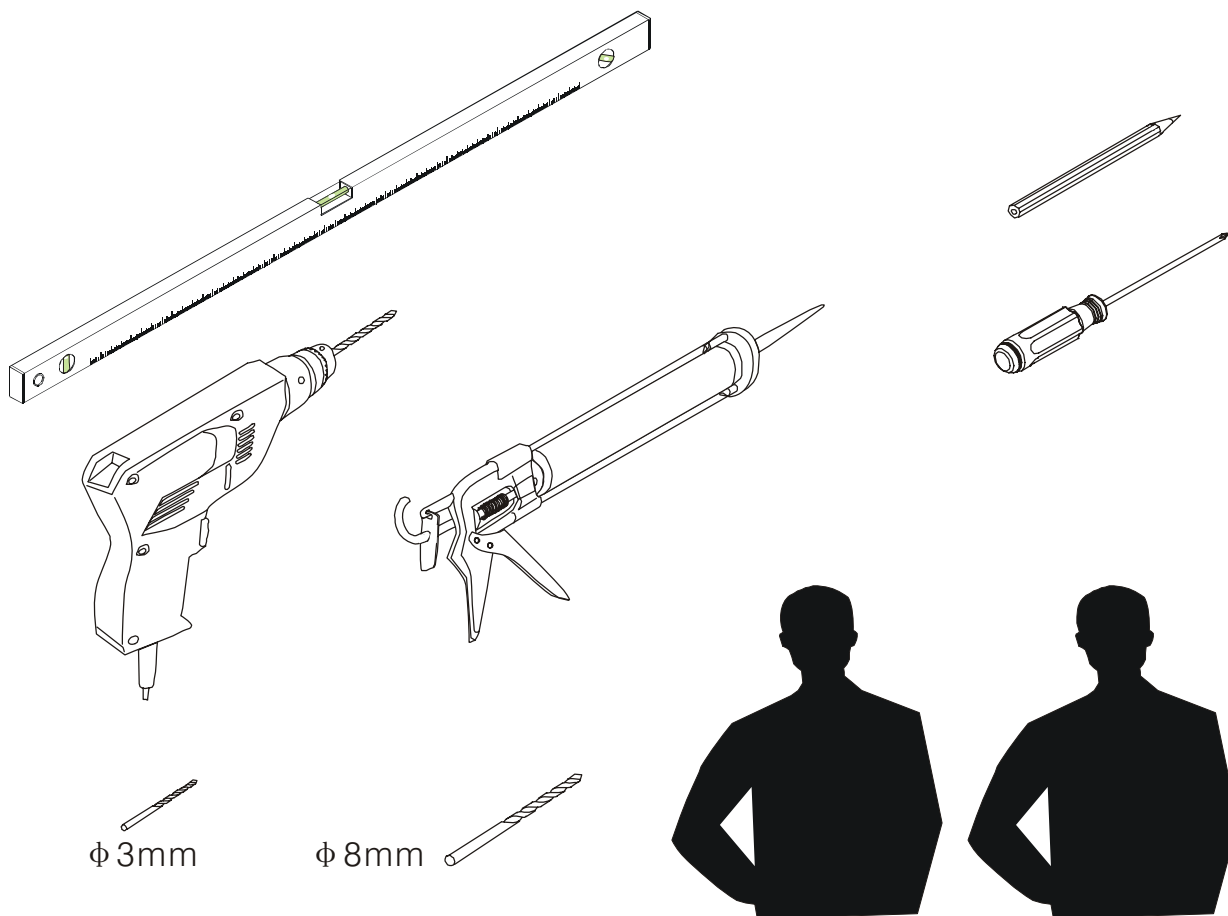

PRODUKT CIĘŻKI WYMAGA DWÓCH OSÓB DO MONTAŻU



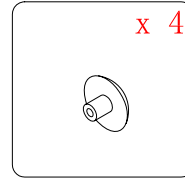
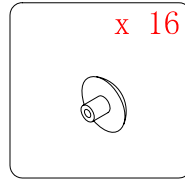
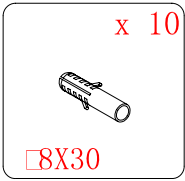
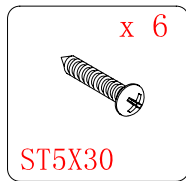
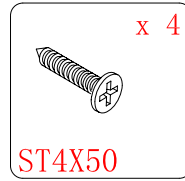
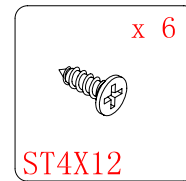
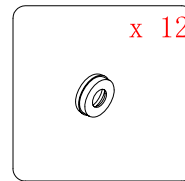
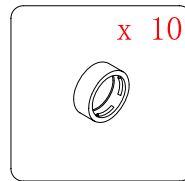
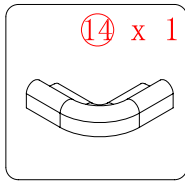
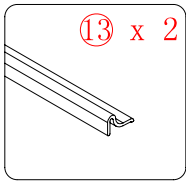
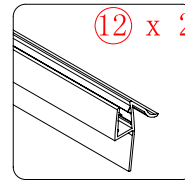
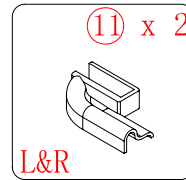
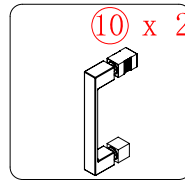
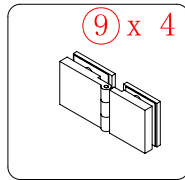
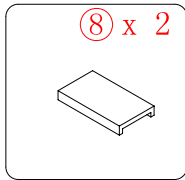
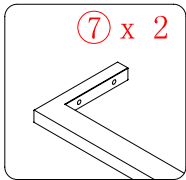
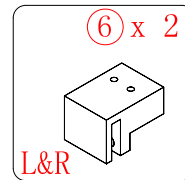
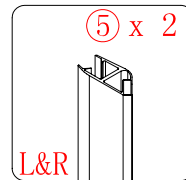
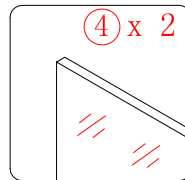
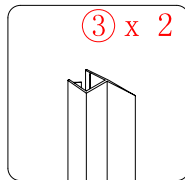
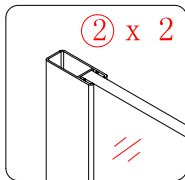
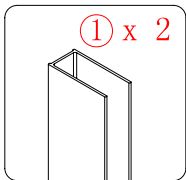
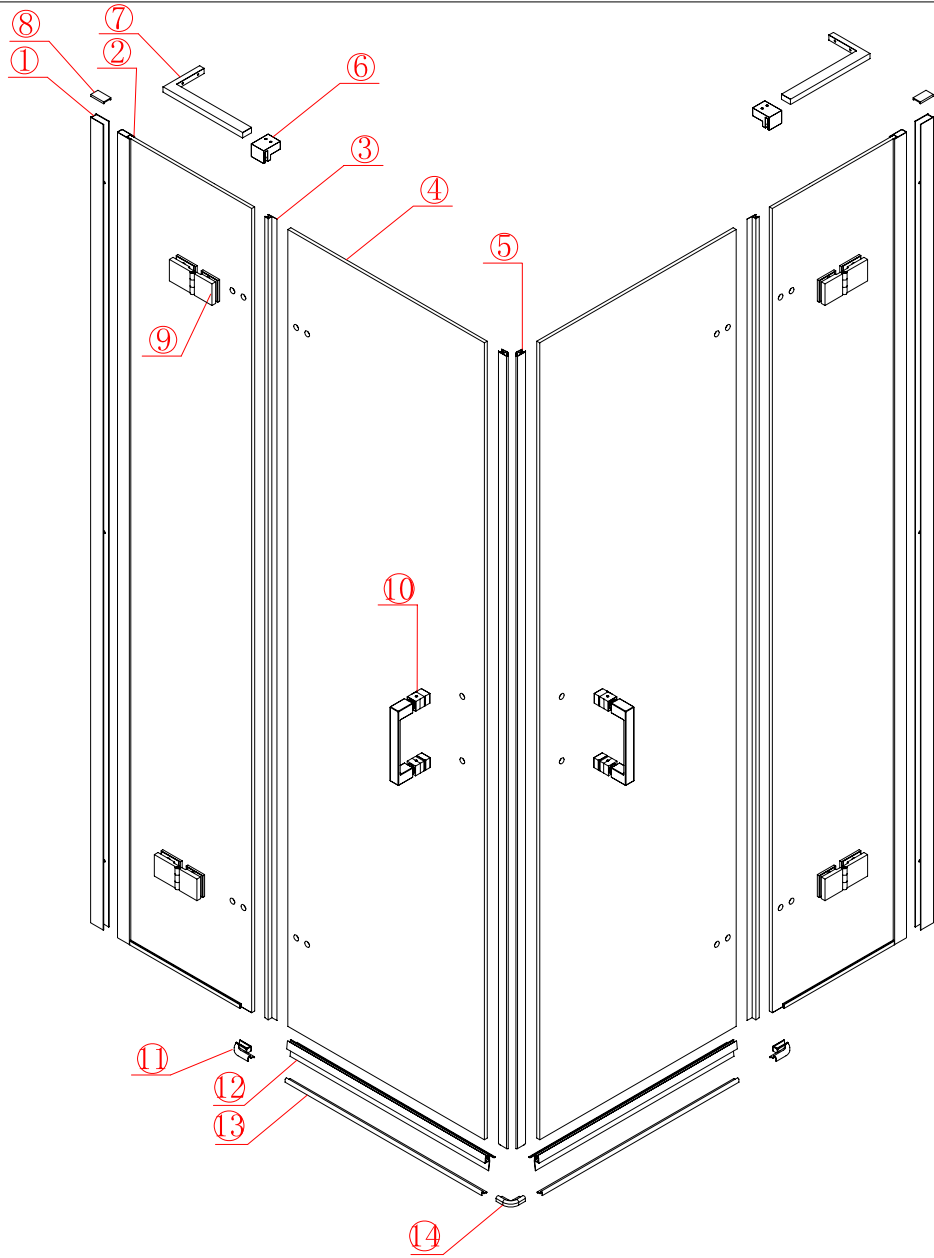

PRODUKT CIĘŻKI WYMAGA DWÓCH OSÓB DO MONTAŻU



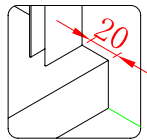
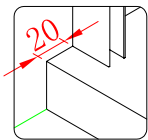
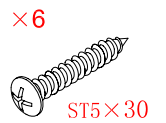
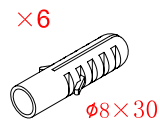
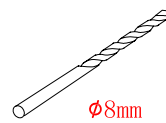
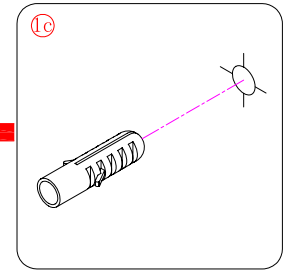
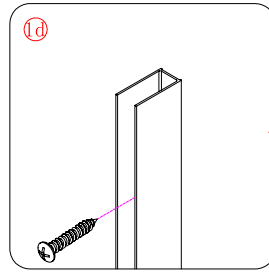
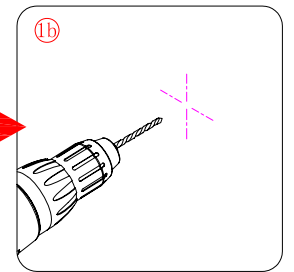
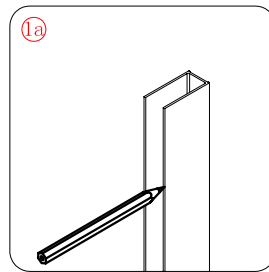
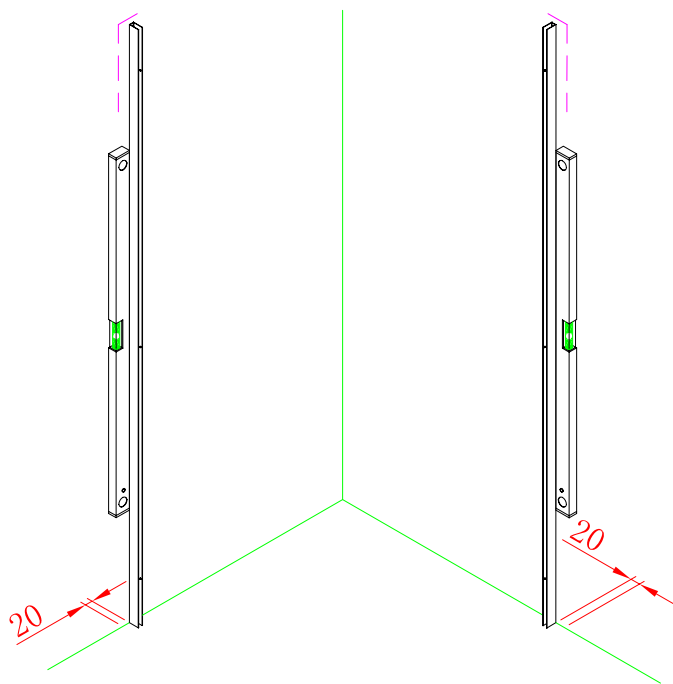

3

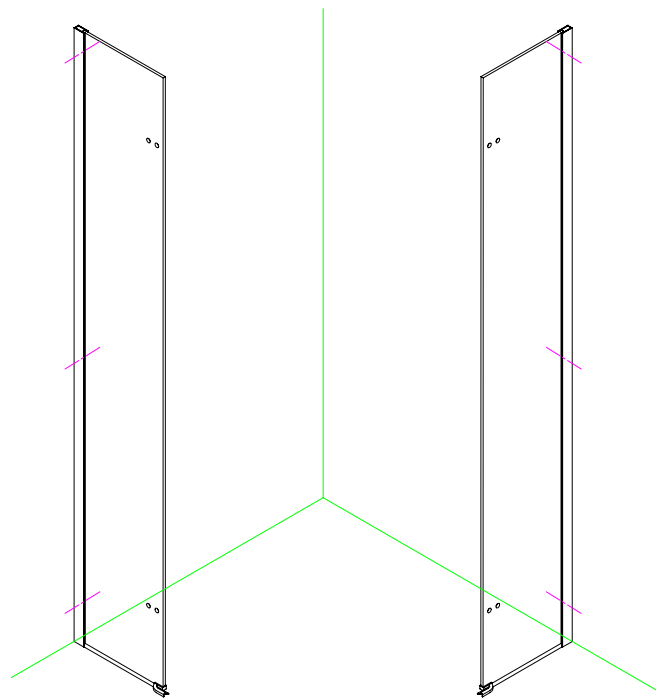
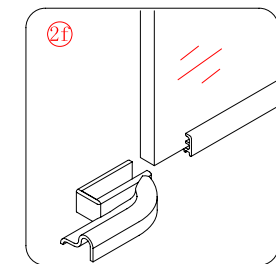
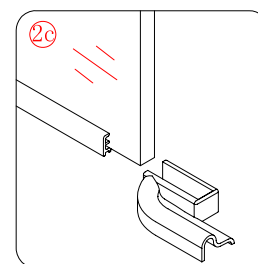
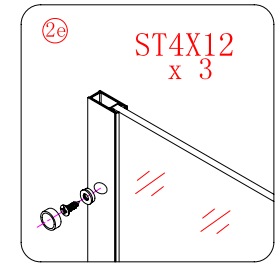
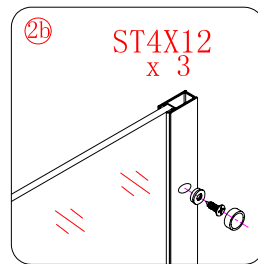
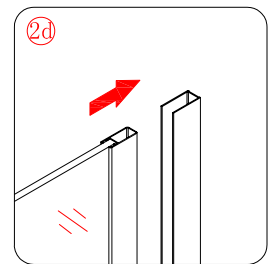
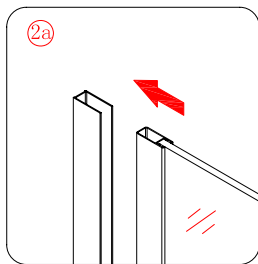

PRODUKT CIĘŻKI WYMAGA DWÓCH OSÓB DO MONTAŻU



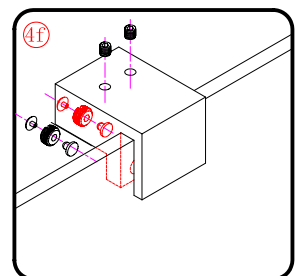
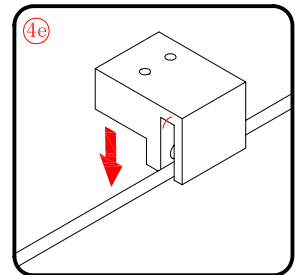
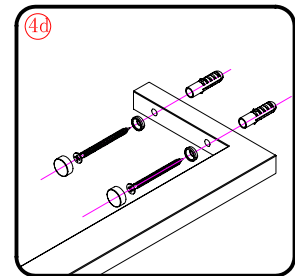
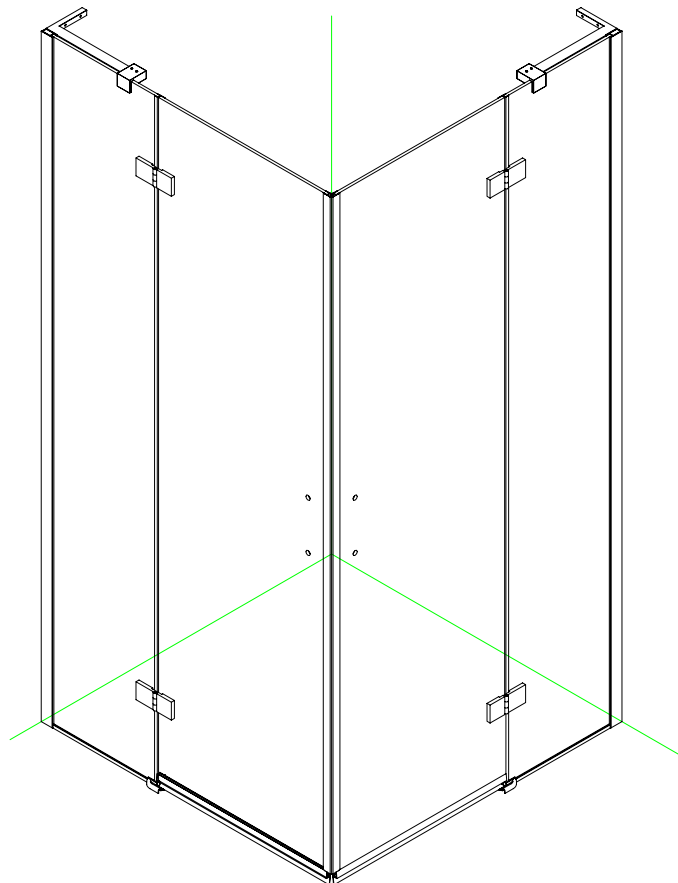
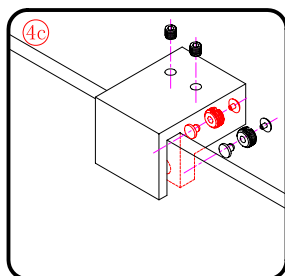
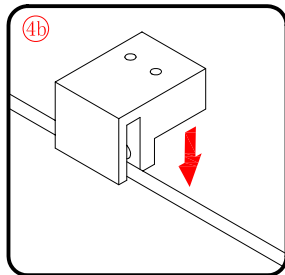
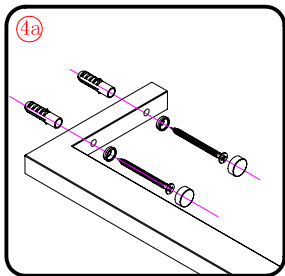
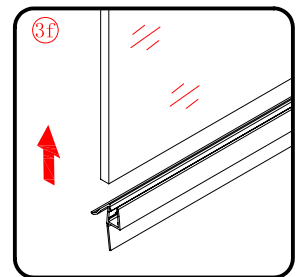
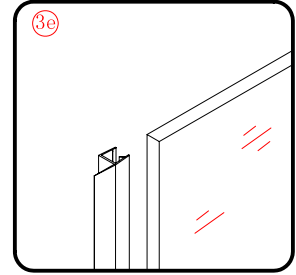
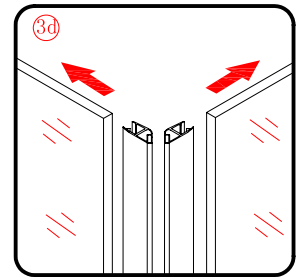
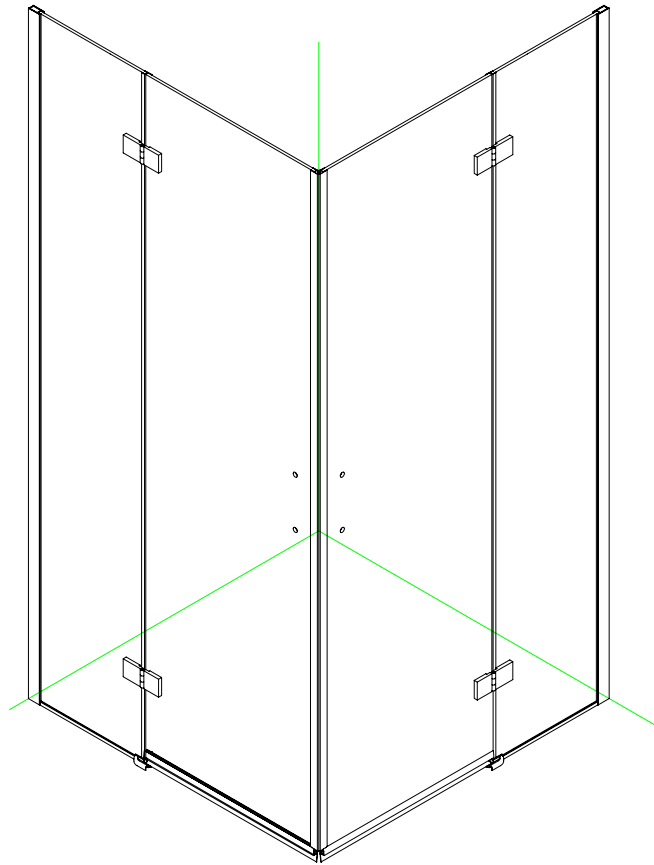
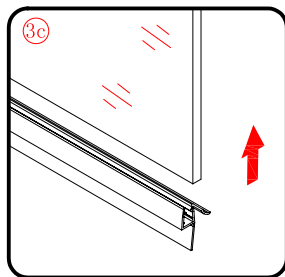
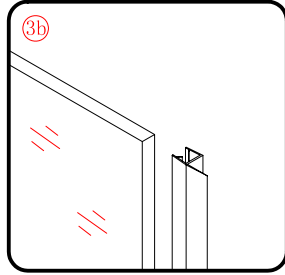
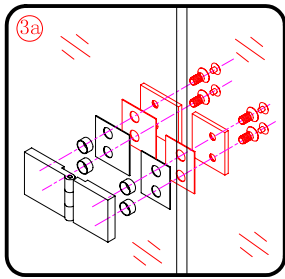

PRODUKT CIĘŻKI WYMAGA DWÓCH OSÓB DO MONTAŻU



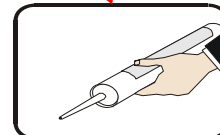
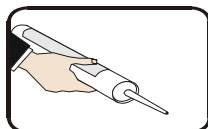
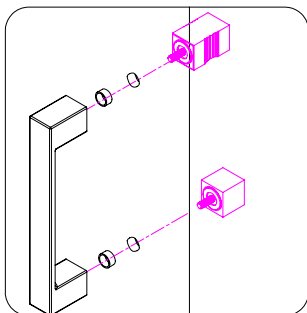
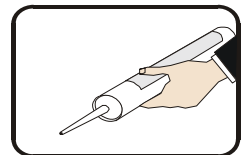
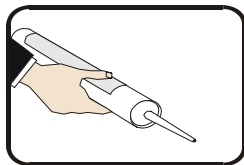
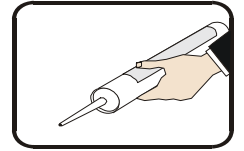
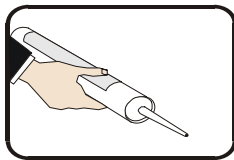
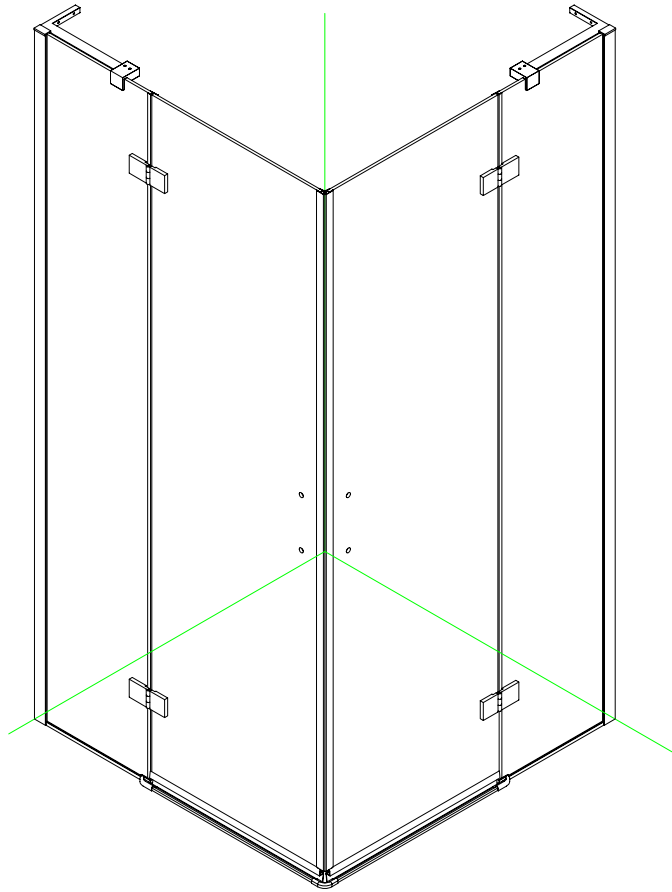
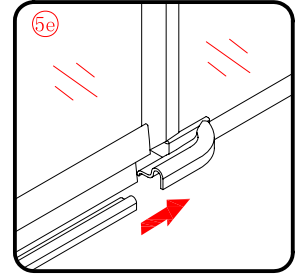
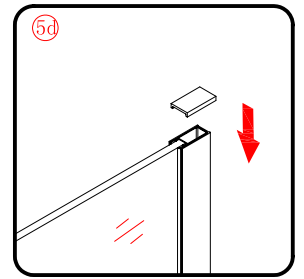
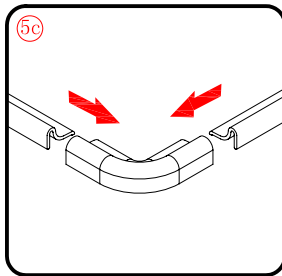
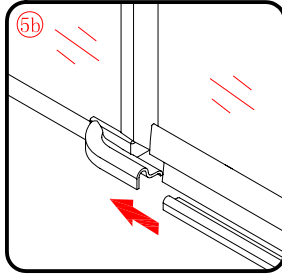
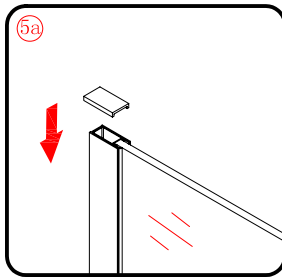

PRODUKT CIĘŻKI WYMAGA DWÓCH OSÓB DO MONTAŻU

